



MOTORTRONICS™

Solid State AC Motor Control

VMX-agility™

REMOTE KEYPAD USER GUIDE



Remote Keypad User Guide

Phasetronics Inc. dba Motortronics
1600 Sunshine Drive
Clearwater, Florida 33765
www.motortronics.com

© 2021 by Phasetronics, all rights reserved

Copyright subsists in all Phasetronics Inc. deliverables including magnetic, optical and/or any other soft copy of these deliverables. This document may not be reproduced, in full or in part, without written permission. Enquiries about copyright of Phasetronics Inc. deliverables should be made to Phasetronics Inc. Ltd. If, by permission of the copyright owner, any part of this document is quoted, then a statement specifying the original document shall be added to the quotation. Any such quotation shall be according to the original (text, figure or table) and may not be shortened or modified.

Connection and Operation

The remote keypad (VMX-AGY-010) can be used to control, monitor and program up to 32 VMX-agility soft starters.

The unit is powered from the host VMX-agility and requires an Ethernet cable for communication (Modbus RTU).

 As the remote keypad acts as the Modbus master, no additional master units must be placed within the network. Failure to observe this may lead to erratic behaviour, network failure and/or equipment



Network Connection

For a configuration where there is only one VMX-agility unit (one-to-one), the remote and main unit can be directly cabled. See Diagram below:

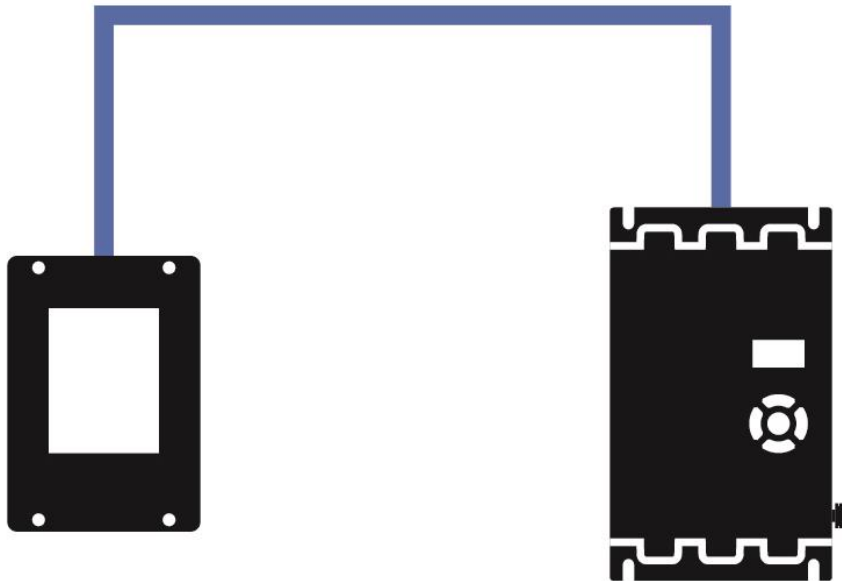



 Keypad power must be enabled on the VMX-agility starter (see below)

Enabling Keypad Power: Scroll to DEVICE menu → KEYPAD menu → KEYPAD PWR = ON

Connection and Operation (continued)

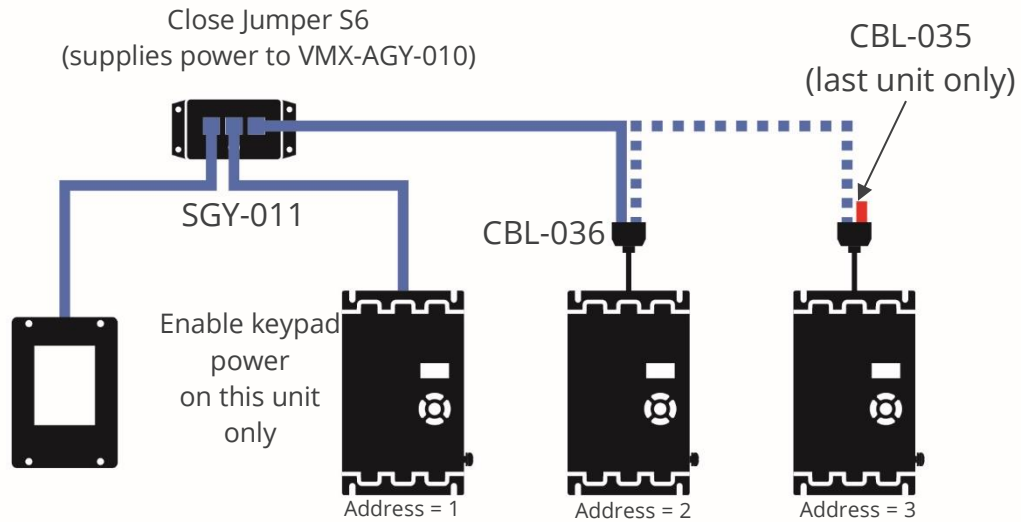
For multiple base units connected to the keypad, the use of SGY-011, CBL-036 and CBL-035 (terminator) is highly recommended. See diagram below.



 **The VMX-agility units must have: a unique Modbus address on each unit and identical Parity/Baud rate values on each unit**

Operation

Once connected to the VMX-agility host unit/s, menu structures and programming are the same as detailed in the VMX-agility manuals MAN-AGY-007 and MAN-AGY-011 (both may be downloaded from www.motortronics.com).

However, specific steps must be taken to connect the Remote Keypad to one or more VMX-agility host units.

Initial Power-Up

If the host VMX-agility unit/s and the remote keypad have the default Modbus transmission parameters set, and the host unit is powered and has Keypad power set to 'on', the keypad will automatically communicate with the host. The following status screen will be seen:

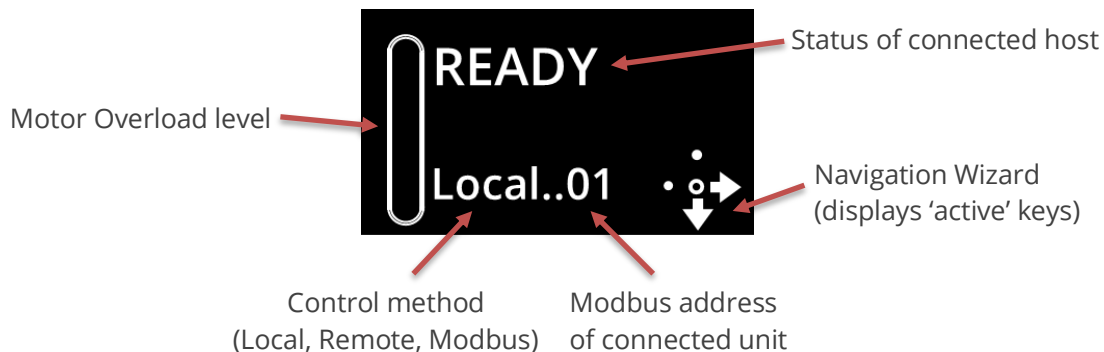

Connection and Operation (continued)

If any of the Modbus communication parameters are dissimilar on the host unit or remote keypad, communication will not be established. The keypad will display the following screen:

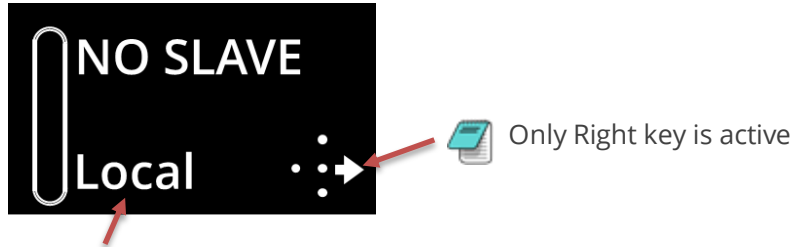

May show: Local, Remote or Modbus

By pressing the Right key, the user will be taken directly to the Modbus address selection menu:

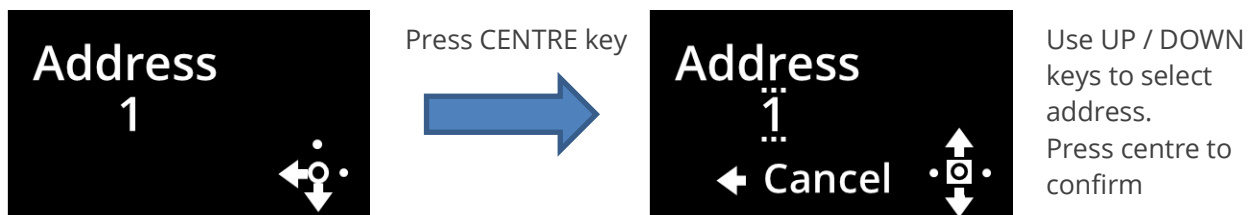

If the selected Modbus address is valid, the status screen is displayed:

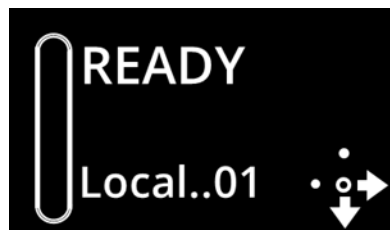

Selecting Units To Monitor/Configure

When the Remote Keypad is attached to multiple VMX-agility units on the Modbus network, the user can switch between each unit by using the following method.

 To simplify this selection process, it is recommended that the host VMX-agility units are configured with consecutive Modbus addresses

(continue on next page)

Connection and Operation (continued)

Procedure:

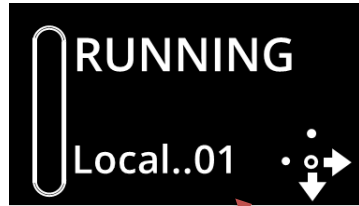

Modbus address
of connected unit

1. Press the 'Right' key
2. Address selection screen will be shown



3. Press the 'Centre' key. Display will change mode

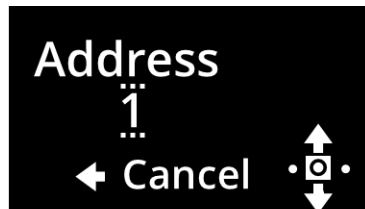

4. Use 'Up' or 'Down' keys to change address to the desired number (VMX-agility address). Press the 'Centre' key to confirm
5. Remote display will return to the Status screen and display the new address.

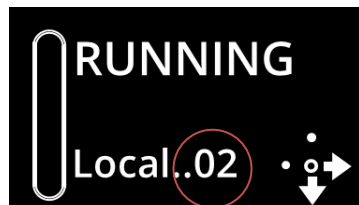

Available Monitors

The following monitors can be viewed on the keypad.

- I rms (Average Current)
- I1 rms (Phase current I1 Rms)
- I2 rms (Phase current I2 Rms)
- I3 rms (Phase current I3 Rms)
- Overload
- Rotation
- HS Temp
- Delay Angle
- Frequency
- RX Bytes
- TX Bytes
- RX Errors
- TX Errors
- Starts per Hour
- Initial Deg C
- Automatic Restart Pending
- Automatic Restart Exceeded
- Automatic Restart Delay
- Automatic Restart Attempts
- Automatic Trip Free
- Automatic Restart Event

Installation

Mounting

Fix the unit to a flat, vertical surface using the mounting holes in the keypad enclosure.

- The orientation of the unit has the 'TOP' uppermost.
- The location allows adequate front access.
- The screen can be viewed

Do not install other equipment that generates significant heat close to the keypad.

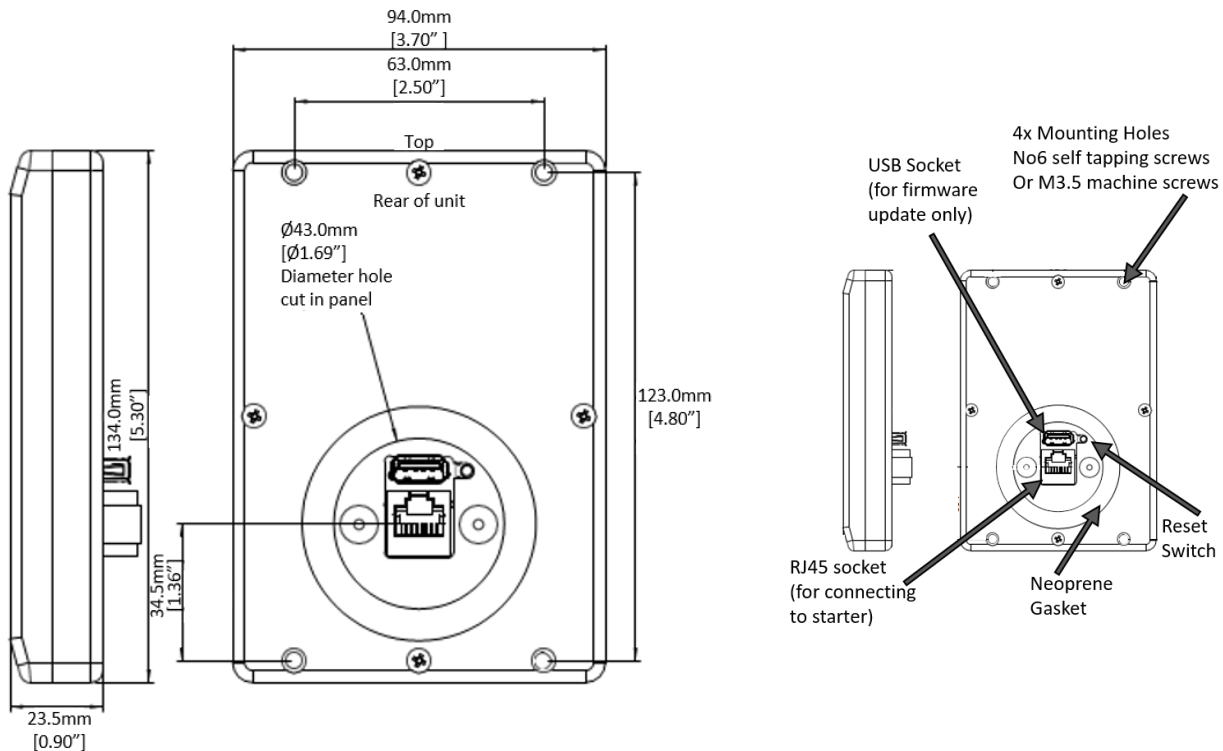

Firmware Update

1. Download the latest firmware version from www.motortronics.com and copy the files to a USB flash drive.
2. Power down the Remote Keypad and insert the USB flash.
3. Power-up the remote Keypad, the update will start automatically
4. When the update is complete (status screen shown), recycle the Remote Keypad power.



Note: The host units and Keypad must have the same firmware version.

California Customers:

California Proposition 65 Warning

WARNING: this product and associated accessories may contain chemicals known to the State of California to cause cancer, birth defects, or other reproductive harm. For more information visit <https://p65warnings.ca.gov>



MOTORTRONICS™

Solid State AC Motor Control

VMX-agility™

REMOTE KEYPAD USER GUIDE

Phasetronics, Inc. dba Motortronics
1600 Sunshine Drive
Clearwater, Florida 33765
USA

Tel: +1 727.573.1819 or 888.767.7792
Fax: +1 727.573.1803 or 800.548.4104

www.motortronics.com